

Chapter 8: Multiplexing

Multiplexing

- What is multiplexing?
 - Frequency-Division Multiplexing
 - Time-Division Multiplexing (Synchronous)
 - Statistical Time-Division Multiplexing, etc.

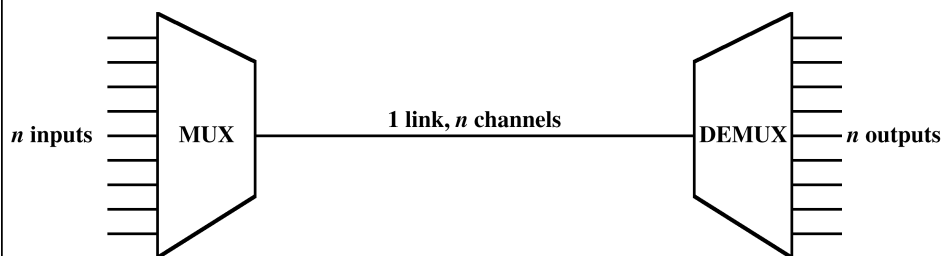

Frequency Division Multiplexing

- FDM
- Useful bandwidth of medium exceeds required bandwidth of channel
- Each signal is modulated to a different carrier frequency
- Carrier frequencies separated so signals do not overlap (guard bands)
 - e.g. broadcast radio
- Channel allocated even if no data

Frequency Division Multiplexing Diagram

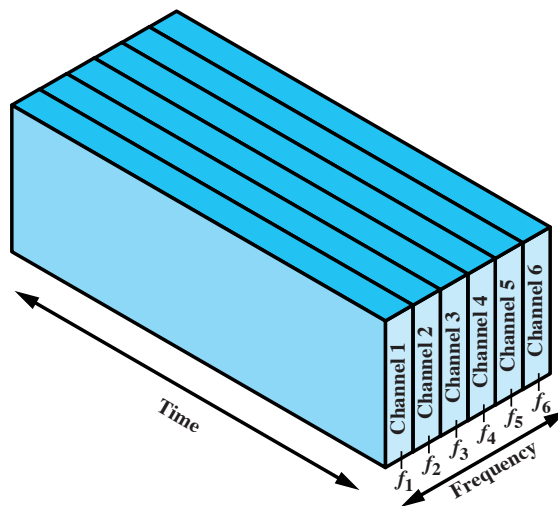

FDM System

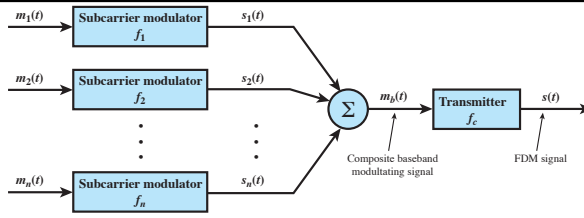

(a) Transmitter

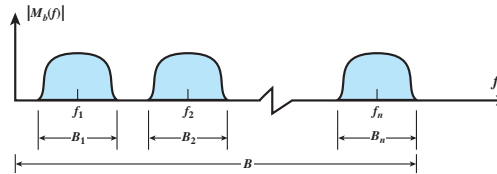

(b) Spectrum of composite baseband modulating signal

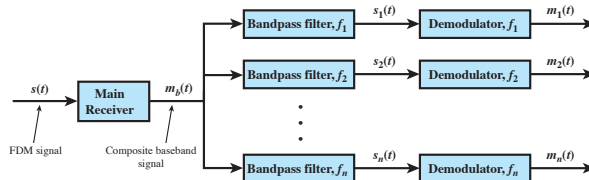

(c) Receiver

CS420/520 Axel Krings

Sequence 8

FDM of three Voicebands

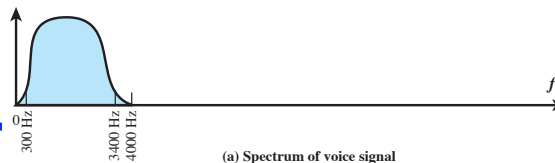

(a) Spectrum of voice signal

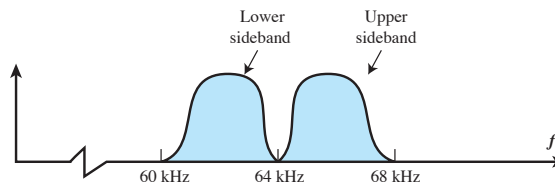

(b) Spectrum of voice signal modulated on 64 kHz frequency

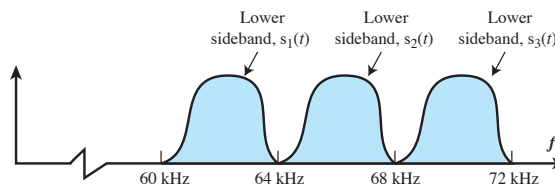

(c) Spectrum of composite signal using subcarriers at 64 kHz, 68 kHz, and 72 kHz

CS420/520 Axel Krings

Sequence 8

Analog Carrier Systems

- Long-distance links use FDM hierarchy
- AT&T (USA) ITU-T (International) variants
- Group
 - 12 voice channels (4kHz each) = 48kHz
 - Range 60kHz to 108kHz
- Supergroup
 - FDM of 5 group signals on carriers between 420kHz and 612 kHz
 - supports 60 channels (=5*12 ☺)
- Mastergroup
 - 10 supergroups, which supports 600 channels

North American and International FDM Carrier Standards

Number of Voice Channels	Bandwidth	Spectrum	AT&T	ITU-T
12	48 kHz	60–108 kHz	Group	Group
60	240 kHz	312–552 kHz	Supergroup	Supergroup
300	1.232 MHz	812–2044 kHz		Mastergroup
600	2.52 MHz	564–3084 kHz	Mastergroup	
900	3.872 MHz	8.516–12.388 MHz		Supermaster group
$N \times 600$			Mastergroup multiplex	
3,600	16.984 MHz	0.564–17.548 MHz	Jumbogroup	
10,800	57.442 MHz	3.124–60.566 MHz	Jumbogroup multiplex	

Wavelength Division Multiplexing (WDM)

- Multiple beams of light at different frequency carried by optical fiber
 - A form of FDM
- Each colour of light (wavelength) carries separate data channel
 - most WDM use single mode fiber optical cable (9µm core)
- 1997 Bell Labs
 - 100 beams, each at 10 Gbps
 - Giving 1 terabit per second (Tbps)
- Commercial systems of 160 channels of 10 Gbps now available
- Lab systems (Alcatel) 256 channels at 39.8 Gbps each
 - 10.1 Tbps
 - Over 100km span

ITU WDM Channel Spacing (G.692)

Frequency (THz)	Wavelength in Vacuum (nm)	50 GHz	100 GHz	200 GHz
196.10	1528.77	X	X	X
196.05	1529.16	X		
196.00	1529.55	X	X	
195.95	1529.94	X		
195.90	1530.33	X	X	X
195.85	1530.72	X		
195.80	1531.12	X	X	
195.75	1531.51	X		
195.70	1531.90	X	X	X
195.65	1532.29	X		
195.60	1532.68	X	X	
...	...			
192.10	1560.61	X	X	X

Dense Wavelength Division Multiplexing

- DWDM
- Implies more channels more closely spaced than WDM
- 200GHz or less could be considered “dense”
- Recommendation ITU-T G.694.1
 - Check it out to see what recommendations look like

Dense Wavelength Division Multiplexing

ITU-T

TELECOMMUNICATION
STANDARDIZATION SECTOR
OF ITU

G.694.1

(02/2012)

SERIES G: TRANSMISSION SYSTEMS AND MEDIA,
DIGITAL SYSTEMS AND NETWORKS

Transmission media and optical systems characteristics –
Characteristics of optical systems

**Spectral grids for WDM applications: DWDM
frequency grid**

Time Division Multiplexing

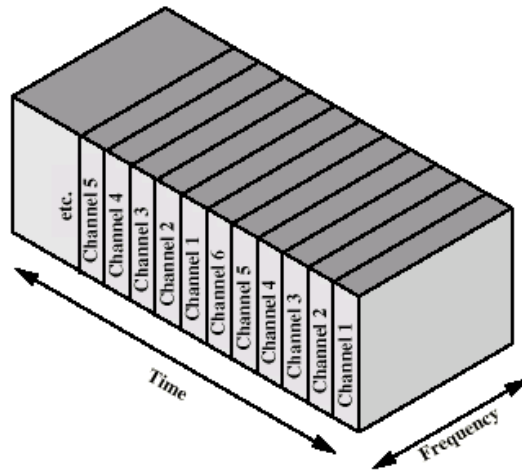

Time-Division Multiplexing TDM (synchronous)

- fixed time slots: take your turn or lose it
- each slot is of duration T
- frame is of duration NT and then repeats itself
- X sends at constant data rate and Y receives at that rate - no buffering or flow control needed - though channels may have own flow control (such as V.24 DSR/DTR and RTS/CTS)
- errors on one channel do not affect behavior of system
- character interleaving - can eliminate start/stop bits and reinsert later for asynchronous sources
- can use 1 bit/frame to indicate slot/frame alignment (101010...)
- differing data rates managed by buffers and use-based allocation

TDM System

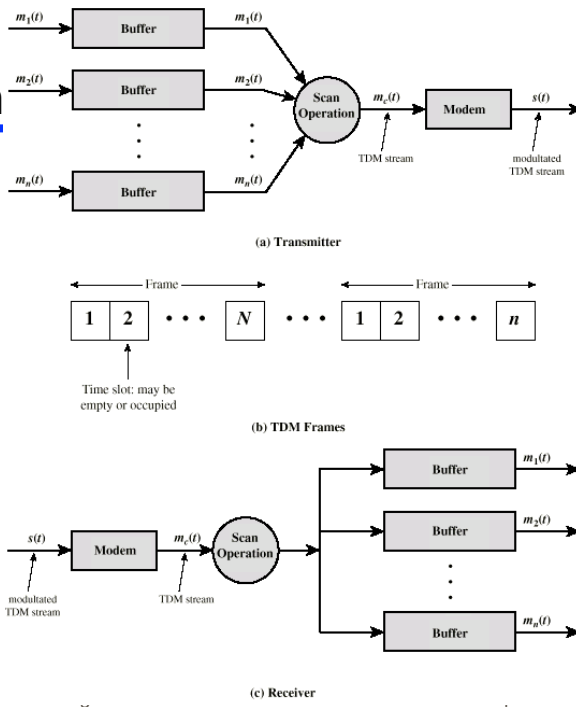

CS420/520 Axel Krings

Multiplexing

—TDM Link Control

- multiplexer does not need link control
- data rate on the multiplexed lines is fixed
- what does one do if a channel is down?
 - Some channel might not send data
 - Answer: tough luck - the efficiency goes down - no big deal
- what does one do if the data on a channel is corrupted?
 - Need error control within the multiplexer?
 - Answer: data link control (e.g. HDLC) on a per-channel basis

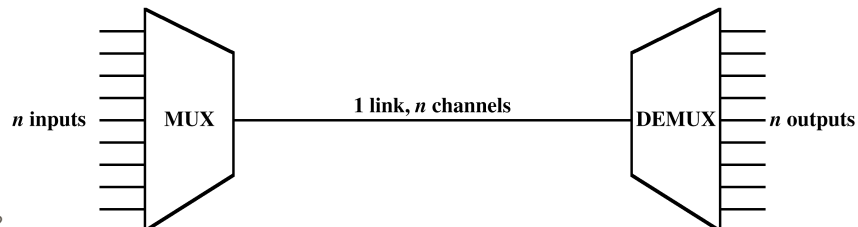

CS42

ice 8

Multiplexing

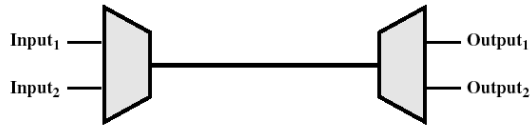

(a) Configuration

Input₁..... F₁ f₁ f₁ d₁ d₁ d₁ C₁ A₁ F₁ f₁ f₁ d₁ d₁ d₁ C₁ A₁ F₁
 Input₂... F₂ f₂ f₂ d₂ d₂ d₂ d₂ C₂ A₂ F₂ f₂ f₂ d₂ d₂ d₂ d₂ C₂ A₂ F₂

(b) Input data streams

... f₂ F₁ d₂ f₁ d₂ f₁ d₂ d₁ d₂ C₁ A₂ C₁ F₂ A₁ f₂ F₁ f₂ f₁ d₂ f₁ d₂ d₁ d₂ d₁ d₂ d₁ C₂ C₁ A₂ A₁ F₂ F₁

(c) Multiplexed data stream

Legend: F = flag field d = one octet of data field
 A = address field f = one octet of FCS field
 C = control field

Multiplexing

—Framing

- character interleaving - can eliminate start/stop bits and reinsert later for asynchronous sources
- need some synchronization
 - if no synchronization is provided to prevent input and output to get out of step
- “added-digit framing”
 - use 1 bit/frame to indicate slot/frame alignment
 - alternate this bit
 - kind of “logical channel with pattern (101010...) pattern”
 - if synchronization is lost, look at successive frames to find the pattern again.
 - This is called “framing search mode”

Multiplexing

—Pulse Stuffing

- big problem is synchronizing various data sources
 - if sources have different clocks: all clocks drift a little bit
 - data rates of input data stream might not be related by a simple rational number
- principle
 - design output data rate bigger than input data rate
 - stuff dummy bits into input data stream until its rate is raised to that of the locally generated clock signal.
 - The stuffing bits are removed by the demultiplexer

TDM of Analog and Digital Sources

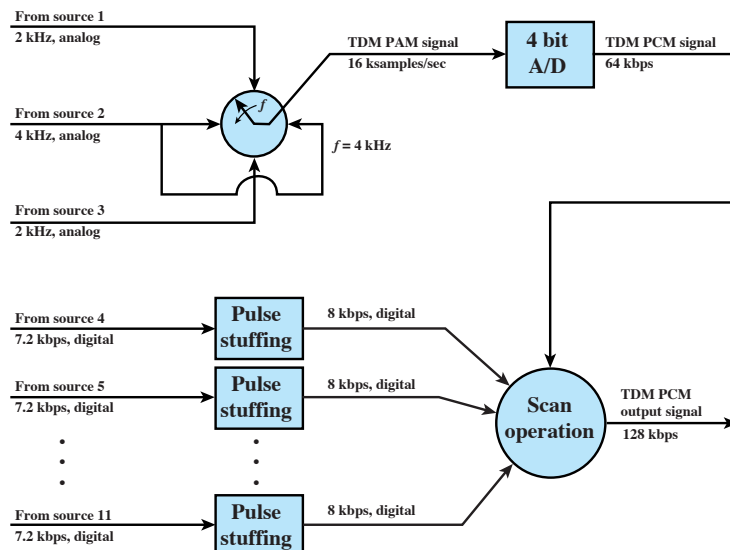

Digital Carrier Systems

- Hierarchy of TDM
- USA/Canada/Japan use one system
- ITU-T use a similar (but different) system
- US system based on DS-1 format
- Multiplexes 24 channels
- Each frame has 8 bits per channel plus one framing bit
- 193 bits per frame

Digital Carrier Systems (2)

- For voice each channel contains one word of digitized data (PCM, 8000 samples per sec)
 - Data rate $8000 \times 193 = 1.544\text{Mbps}$
 - Five out of six frames have 8 bit PCM samples
 - Sixth frame is 7 bit PCM word plus signaling bit
 - Signaling bits form stream for each channel containing control and routing info
- Same format for digital data
 - 23 channels of data
 - 7 bits per frame plus indicator bit for data or systems control
 - 24th channel is sync

Mixed Data

DS-1 can carry mixed voice and data signals

- voice digitization: 4kHz => 8000 samples/s
 - 8 bit sample every 125 microseconds
 - in US 24 voice channels grouped together (30 for ITU-I)
 - resulting aggregate bit rate is 1.544 Mbps (2.048Mbps)
 - actually $(24 \times 8 + 1)\text{bits}/125\mu\text{s} = 1.544\text{Mbps}$
 - called DS1 or T1 link
 - $4 \times \text{T1} = \text{T2}$
 - $7 \times \text{T2} = \text{T3}$
 - $6 \times \text{T3} = \text{T4}$

Multiplexing

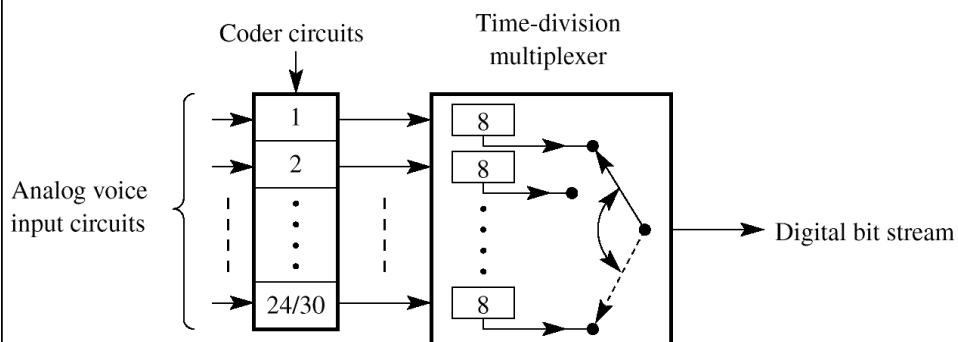

Hal96 fig 2.26

Multiplexing

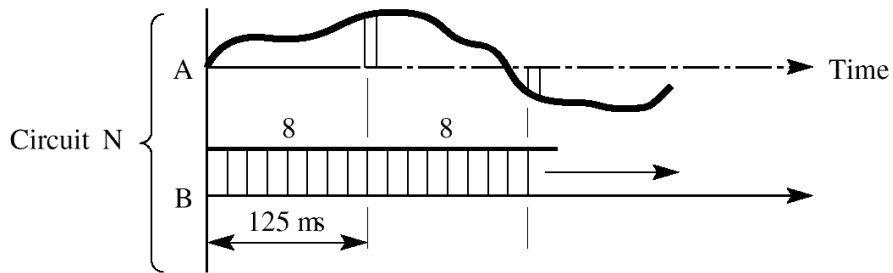

Hal96 fig 2.26

DS-1 Transmission Format

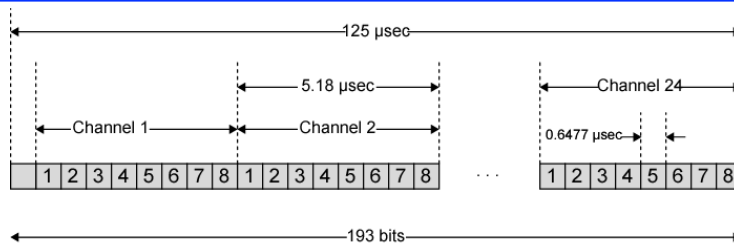

Notes:

1. The first bit is a framing bit, used for synchronization.
2. Voice channels:
 - 8-bit PCM used on five of six frames.
 - 7-bit PCM used on every sixth frame; bit 8 of each channel is a signaling bit.
3. Data channels:
 - Channel 24 is used for signaling only in some schemes.
 - Bits 1-7 used for 56 kbps service
 - Bits 2-7 used for 9.6, 4.8, and 2.4 kbps service.

Multiplexing

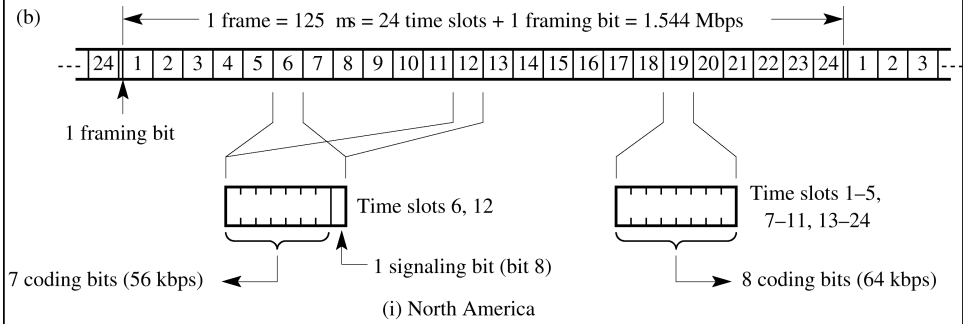

Hal96 fig 2.26

Multiplexing

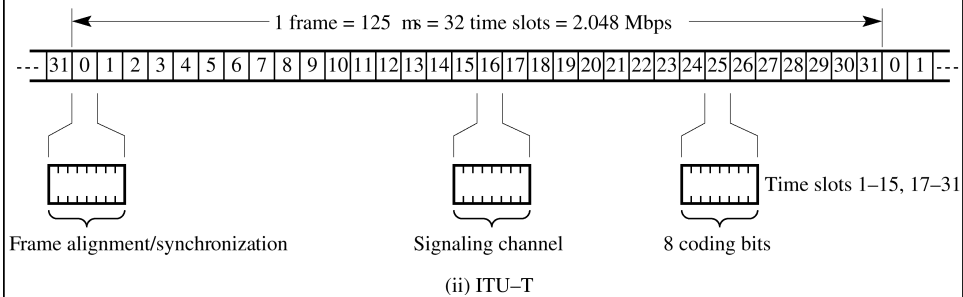

Hal96 fig 2.26

TDM Carrier Standards

- North America (based on 24 channels)

Designation	North American			International (ITU-T)	
	# voice channels	Data Rate (Mbps)	Level	# voice channels	Data Rate (Mbps)
DS-1	24	1.544	1	30	2.048
DS-1C	48	3.152	2	120	8.448
DS-2	96	6.312	3	480	34.368
DS-3	672	44.736	4	1920	139.264
DS-4	4032	274.176	5	7680	565.148
DS-5	5760	400.352			

SONET/SDH

- Synchronous Optical Network (ANSI)
- Synchronous Digital Hierarchy (ITU-T)
- Compatible
- Signal Hierarchy
 - Synchronous Transport Signal level 1 (STS-1)
 - or Optical Carrier level 1 (OC-1)
 - 51.84Mbps
 - Carry DS-3 or group of lower rate signals (DS1 DS1C DS2) plus ITU-T rates (e.g. 2.048Mbps)
 - Multiple STS-1 combined into STS-N signal
 - ITU-T lowest rate is 155.52Mbps (STM-1)

SONET Frame Format

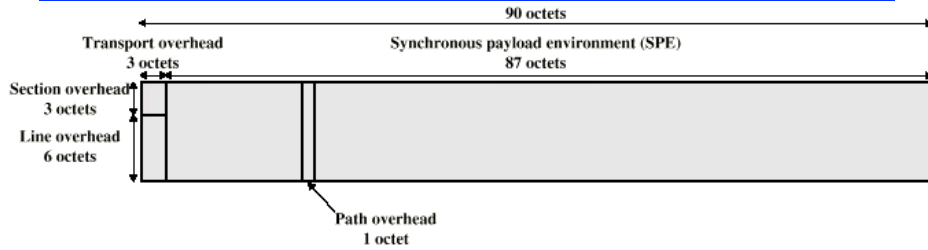

(a) STS-1 frame format

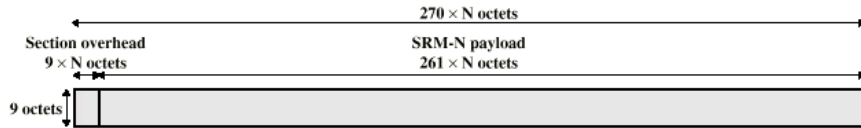

(b) STM-N frame format

SONET STS-1 Overhead Octets

Section Overhead	Framing A1	Framing A2	STS-ID C1	Trace J1	
	BIP-8 B1	Orderwire E1	User F1		BIP-8 B3
	DataCom D1	DataCom D2	DataCom D3		Signal Label C2
	Pointer H1	Pointer H2	Pointer Action H3		Path Status G1
	BIP-8 B2	APS K1	APS K2		User F2
	DataCom D4	DataCom D5	DataCom D6		Multiframe H4
Line Overhead	DataCom D7	DataCom D8	DataCom D9	Growth Z3	
	DataCom D10	DataCom D11	DataCom D12	Growth Z4	
	Growth Z1	Growth Z2	Orderwire E2	Growth Z5	

(a) Transport Overhead

(b) Path Overhead

Statistical TDM

- In Synchronous TDM many slots are wasted
- Statistical TDM allocates time slots dynamically based on demand
 - Make use of the fact that slots are not always active, so can support more devices on same channel
 - Requires use of extra overhead for identifying channel, and buffering

Multiplexing

- Statistical Multiplexer principle

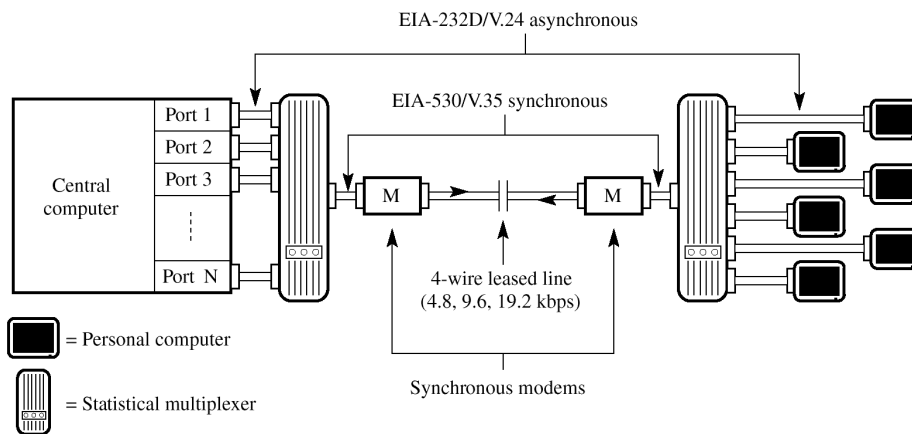

Statistical TDM Frame Formats



(a) Overall frame



(b) Subframe with one source per frame

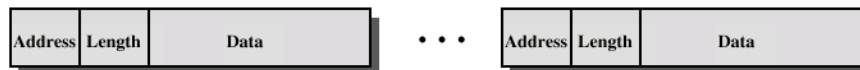

(c) Subframe with multiple sources per frame

Performance

- Output data rate less than aggregate input rates
- May cause problems during peak periods
 - Buffer inputs
 - Keep buffer size to minimum to reduce delay

Multiplexing

- let m_c be maximum data rate of multiplexed trunk
 - let m_i be maximum data rate of source i
 - m_c can be less than the sum of all m_i iff probabilities p_i are such that the sum of $p_i m_i$ is less than m_c : By how much? (rule of thumb is 80%)
- Example: How many 9600bps terminals can be supported on a 56Kbps line using TDM if p_i 75%?

Buffer Size and Delay

assume data is transmitted in 1000-bit frames

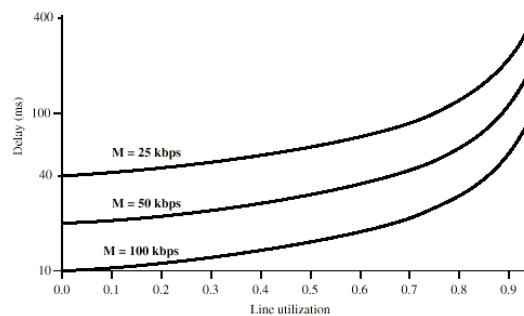
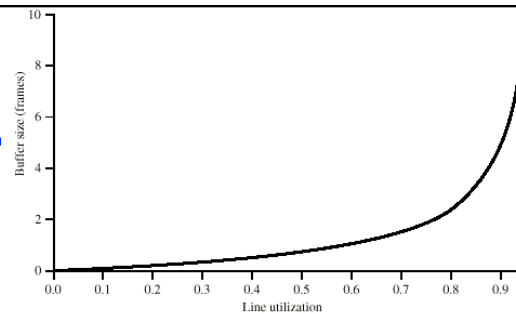

Cable Modem Outline

- Two channels from cable TV provider dedicated to data transfer
 - One in each direction
- Each channel shared by number of subscribers
 - Scheme needed to allocate capacity
 - Statistical TDM

Cable Modem Operation

- Downstream
 - Cable scheduler delivers data in small packets
 - If more than one subscriber active, each gets fraction of downstream capacity
 - e.g., may get 500kbps to 20Mbps
 - Also used to allocate upstream time slots to subscribers
- Upstream
 - User requests timeslots on shared upstream channel
 - Dedicated slots for this
 - Headend scheduler sends back assignment of future time slots to subscriber

Cable Modem Scheme

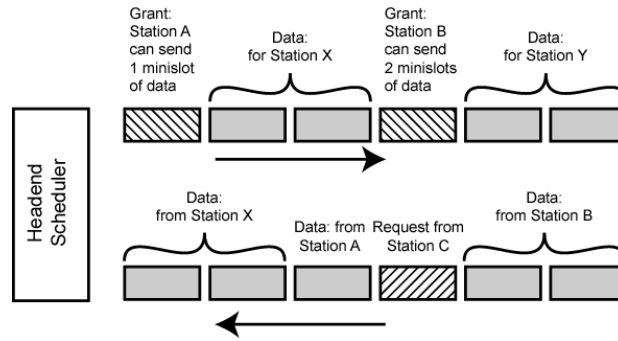

Asymmetrical Digital Subscriber Line

- ADSL
- Link between subscriber and network
 - Local loop
- Uses currently installed twisted pair cable
 - Can carry broader spectrum
 - 1 MHz or more

ADSL Design

- Asymmetric
 - Greater capacity downstream than upstream
- Frequency division multiplexing
 - Lowest 25kHz for voice
 - Plain old telephone service (POTS)
 - Use echo cancellation or FDM to give two bands
 - Use FDM within bands
- Range 5.5km

ADSL Channel Configuration

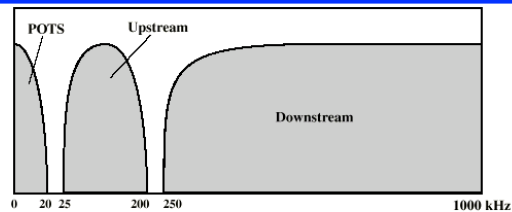

(a) Frequency-division multiplexing

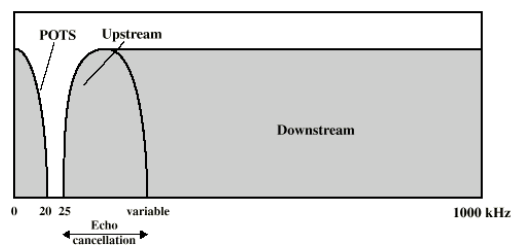

(b) Echo cancellation

Discrete Multitone

- DMT
- Multiple carrier signals at different frequencies
- Some bits on each channel
- 4kHz subchannels
- Send test signal and use subchannels with better signal to noise ratio
- 256 downstream subchannels at 4kHz (60kbps)
 - 15.36MHz
 - Impairments bring this down to 1.5Mbps to 9Mbps

DMT Bits Per Channel Allocation

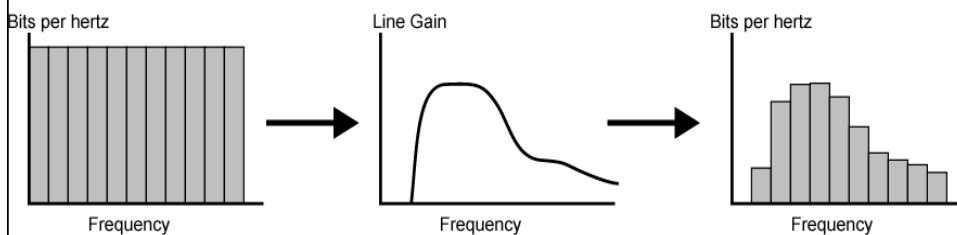

DMT Transmitter

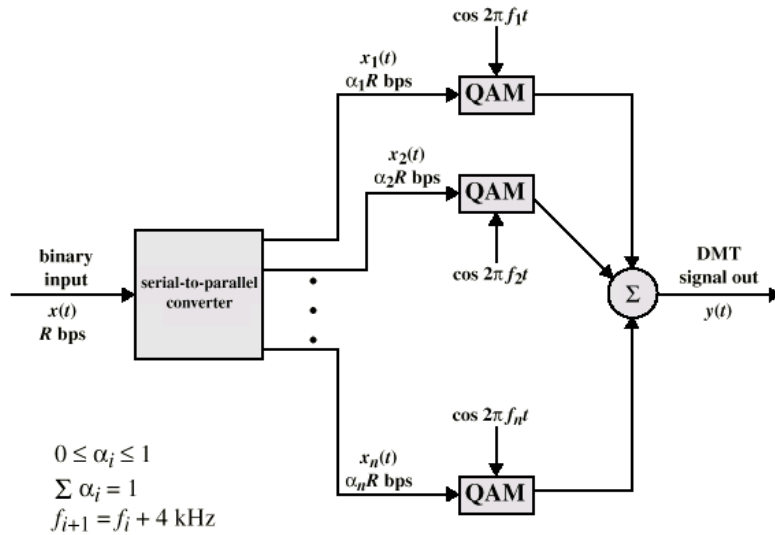

CS420/520 Axel Krings

Page 47

Sequence 8

xDSL

- High data rate DSL
- Single line DSL
- Very high data rate DSL

	ADSL	HDSL	SDSL	VDSL
Data rate	1.5 to 9 Mbps downstream 16 to 640 kbps upstream	1.544 or 2.048 Mbps	1.544 or 2.048 Mbps	13 to 52 Mbps downstream 1.5 to 2.3 Mbps upstream
Mode	Asymmetric	Symmetric	Symmetric	Asymmetric
Copper Pairs	1	2	1	1
Range (24-gauge UTP)	3.7 to 5.5 km	3.7 km	3.0 km	1.4 km
Signaling	Analog	Digital	Digital	Analog
Line Code	CAP/DMT	2B1Q	2B1Q	DMT
Frequency	1 to 5 MHz	196 kHz	196 kHz	≥ 10 MHz
Bits/cycle	Varies	4	4	Varies

UTP = unshielded twisted pair

CS420/520 Axel Krings

Page 48

Sequence 8