

# **Cellular Wireless Networks**

Chapter 10 in Stallings 10<sup>th</sup> Edition

## **Principles of Cellular Networks**

- Developed to increase the capacity available for mobile radio telephone service
- Prior to cellular radio:
  - Mobile service was only provided by a high powered transmitter/receiver
  - Typically supported about 25 channels
  - Had an effective radius of about 80km

## Cellular Network Organization

- Key for mobile technologies
- Based on the use of multiple low power transmitters
- Area divided into cells
  - Use tiling pattern to provide full coverage
  - Each cell has its own antenna
  - Each with own range of frequencies
  - Served by a base station
    - Consisting of transmitter, receiver, and control unit
  - Adjacent cells are assigned different frequencies to avoid interference or crosstalk
    - Cells sufficiently distant from each other can use the same frequency band

## Shape of Cells

- Square
  - Width  $d$  cell has four neighbors at distance  $d$  and four at distance  $\sqrt{2}d$
  - Better if all adjacent antennas equidistant
    - Simplifies choosing and switching to new antenna
- Hexagon
  - Provides equidistant antennas
  - Radius defined as radius of circum-circle
    - Distance from center to vertex equals length of side
  - Distance between centers of cells radius  $R$  is  $\sqrt{3}R$
  - Not always precise hexagons
    - Topographical limitations
    - Local signal propagation conditions
    - Location of antennas

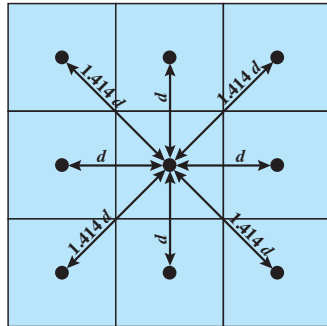

(a) Square pattern

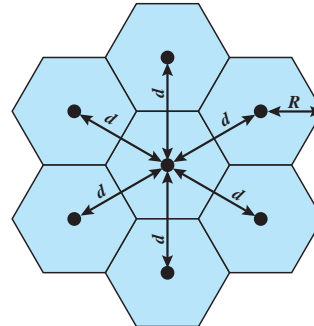

(b) Hexagonal pattern

Figure 10.1 Cellular Geometries

## Frequency Reuse

- Power of base transceiver controlled
  - Allow communications within cell on given frequency
  - Limit escaping power to adjacent cells
  - Want to re-use frequencies in nearby (but not adjacent) cells
  - 10 – 50 frequencies per cell
- *E.g.*
  - Let  $N$  be the number of cells in a pattern, all using same number of frequencies
  - Let  $K$  denote total number of frequencies used in system
  - Each cell can use  $K/N$  frequencies
  - Advanced Mobile Phone Service (AMPS)  $K=395$ ,  $N=7$  giving 56 frequencies per cell on average
    - We are oversimplifying things here as actually there are 2 frequencies per full duplex channel. So behind  $K=395$  there are actually  $2 \times 395 = 790$  individual frequencies.

# Characterizing Frequency Reuse

- $D$  = minimum distance between centers of cells that use the same band of frequencies (called co-channels)
- $R$  = radius of a cell
- $d$  = distance between centers of adjacent cells ( $d = \sqrt{3} R$ )
- $N$  = number of cells in repetitious pattern
  - Reuse factor
  - Each cell in pattern uses unique band of frequencies
- Hexagonal cell pattern, following values of  $N$  possible
  - $N = I^2 + J^2 + (I \times J)$ ,  $I, J = 0, 1, 2, 3, \dots$
- Possible values of  $N$  are 1, 3, 4, 7, 9, 12, 13, 16, 19, 21, ...
  
- $D/R = \sqrt{3N}$
- $D/d = \sqrt{N}$

# Frequency Reuse Patterns

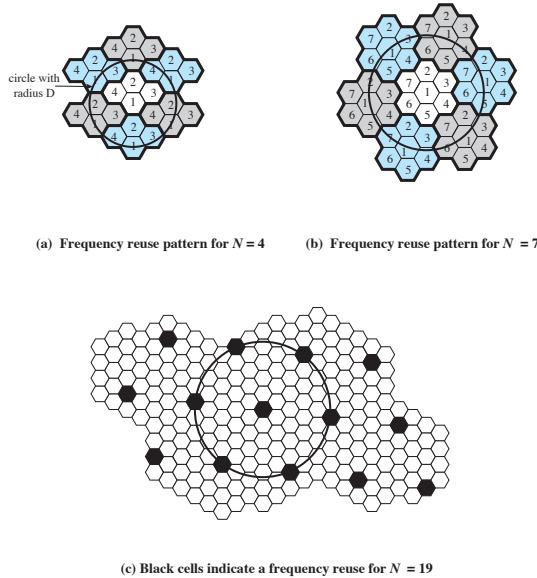

Figure 10.2 Frequency Reuse Patterns

## Increasing Capacity (1)

- Add new channels
  - Not all channels used to start with
- Frequency borrowing
  - Taken from adjacent cells by congested cells
  - Or assign frequencies dynamically
- Cell splitting
  - Non-uniform distribution of topography and traffic
  - Smaller cells in high use areas
    - Original cells 6.5 – 13 km
    - 1.5 km limit in general
    - More frequent handoff
    - More base stations

## Cell Splitting

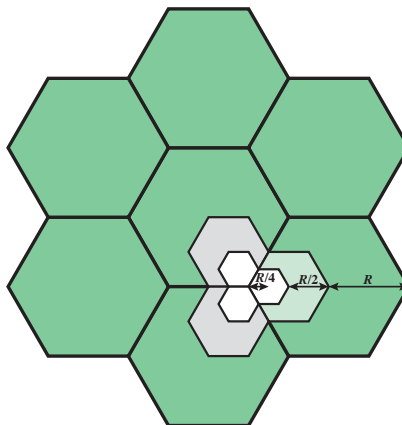

Figure 10.3 Cell Splitting with Cell Reduction Factor of  $F = 2$

## Increasing Capacity (2)

- Cell Sectoring
  - Cell divided into wedge shaped sectors
    - 3 – 6 sectors per cell
  - Each with own channel set
    - Subsets of cell's channels
  - Directional antennas to focus on each sector
- Microcells
  - Move antennas from tops of hills and large buildings to tops of small buildings and sides of large buildings, even lamp posts, to form microcells
  - Reduced power to cover a much smaller area
  - Good for city streets, along roads and inside large buildings

## Frequency Reuse Example

Assume: 32 cells, cell radius = 1.6 km, frequency bandwidth supports 336 channels, reuse factor  $N=7$ .

How many channels per cell? What is total # of concurrent calls?

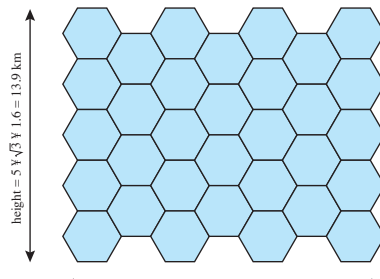

(a) Cell radius = 1.6 km

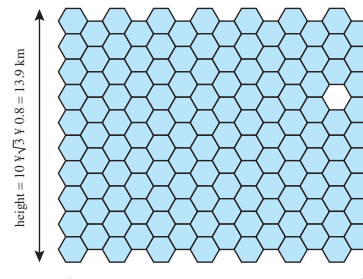

(b) Cell radius = 0.8 km

## Operation of Cellular Systems

- Base station (BS) at center of each cell
  - Antenna, controller, transceivers
- Controller handles call process
  - Number of mobile units may be in use at a time
- BS connected to Mobile Telecommunications Switching Office (MTSO)
  - One MTSO serves multiple BS
  - MTSO to BS link by wire or wireless
- MTSO:
  - Connects calls between mobile units and from mobile to fixed telecommunications network
  - Assigns voice channel
  - Performs handoffs
  - Monitors calls (billing)
- Fully automated

## Overview of Cellular System

Figure 10.5

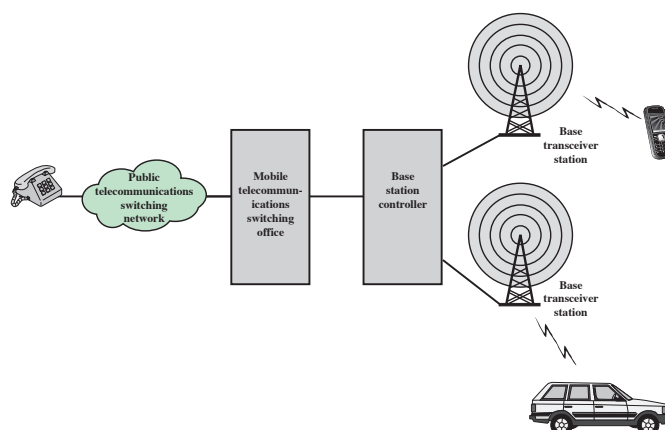

## Two types of Channels

- Control channels
  - Setting up and maintaining calls
  - Establish relationship between mobile unit and nearest BS
- Traffic channels
  - Carry voice and data

## Call Stages

Figure 10.6

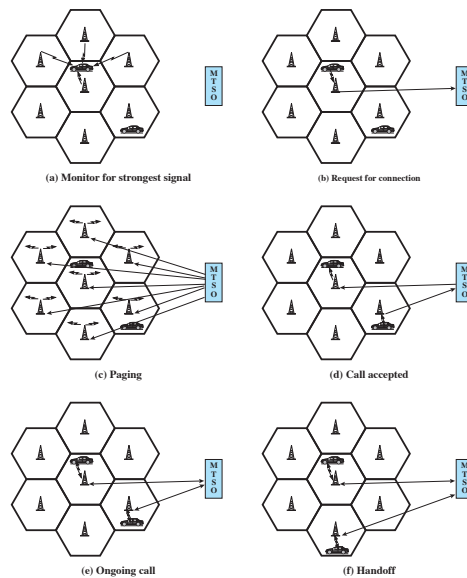

Figure 10.6 Example of Mobile Cellular Call



## **Typical Call in Single MTSO Area (1)**

---

- Mobile unit initialization
  - Scan and select strongest set up control channel
  - Automatically selected BS antenna of cell
    - Usually but not always nearest (propagation anomalies)
  - Handshake to identify user and register location
  - Scan repeated to allow for movement
    - Change of cell
  - Mobile unit monitors for pages (see below)

## **Typical Call in Single MTSO Area (2)**

---

- Mobile originated call
  - Check if set up channel is free
    - Monitor forward channel (from BS) and wait for idle
  - Send number of called unit on preselected setup channel
- Paging
  - MTSO attempts to connect to mobile unit
  - Paging message sent to BSs depending on called mobile number
  - Paging signal transmitted on set up channel

## **Typical Call in Single MTSO Area (3)**

---

- Call accepted
  - Mobile unit recognizes number on set up channel
  - Responds to BS which sends response to MTSO
  - MTSO sets up circuit between calling and called BSs
  - MTSO selects available traffic channel within cells and notifies BSs
  - BSs notify mobile unit of channel

## **Typical Call in Single MTSO Area (4)**

---

- Ongoing call
  - Voice/data exchanged through respective BSs and MTSO
- Handoff
  - Mobile unit moves out of range of cell into range of another cell
  - Traffic channel changes to one assigned to new BS
    - Without interruption of service to user

## **Other Functions**

---

- Call blocking
  - During mobile-initiated call stage, if all traffic channels are busy, mobile tries again
  - After number of fails, busy tone is returned
- Call termination
  - User hangs up
  - MTSO informed
  - Traffic channels at two BSs released

## **Other Functions**

---

- Call drop
  - BS cannot maintain required signal strength
  - Traffic channel dropped and MTSO informed
- Calls to/from fixed and remote mobile subscriber
  - MTSO connects to PSTN
  - MTSO can connect mobile user and fixed subscriber via PSTN
  - MTSO can connect to remote MTSO via PSTN or via dedicated lines
  - Can connect mobile user in its area and remote mobile user

## Mobile Radio Propagation Effects

---

- Signal strength
  - Strength of signal between BS and mobile unit strong enough to maintain signal quality at the receiver
  - Not strong enough to create too much co-channel interference
  - Noise varies
    - Automobile ignition noise greater in city than in suburbs
    - Other signal sources vary
    - Signal strength varies as function of distance from BS
    - Signal strength varies dynamically as mobile unit moves
- Fading
  - Even if signal strength in effective range, signal propagation effects may disrupt the signal

## Design Factors

---

- Propagation effects (dynamic, hard to predict)
  - Maximum transmit power level at BS and mobile units
  - Typical height of mobile unit antenna
  - Available height of the BS antenna
  - These factors determine size of individual cell
- Use model based on empirical data
  - Widely used model developed by Okumura and refined by Hata
    - Detailed analysis of Tokyo area
    - Produced path loss information for an urban environment
  - Hata's model is an empirical formulation that takes into account a variety of conditions

## Fading

---

- Time variation of received signal
- Caused by changes in transmission path(s)
  - E.g. atmospheric conditions (rain)
  - Movement of (mobile unit) antenna

## Multipath Propagation

---

- Reflection
  - Surface large relative to wavelength of signal
  - May have phase shift from original
  - May cancel out original or increase it
- Diffraction
  - Edge of impenetrable body that is large relative to wavelength
  - May receive signal even if no **line of sight** (LOS) to transmitter
- Scattering
  - Obstacle size on order of wavelength
    - Lamp posts etc.
- If LOS, diffracted and scattered signals not significant
  - Reflected signals may be
- If no LOS, diffraction and scattering are primary means of reception

## Reflection, Diffraction, Scattering

---

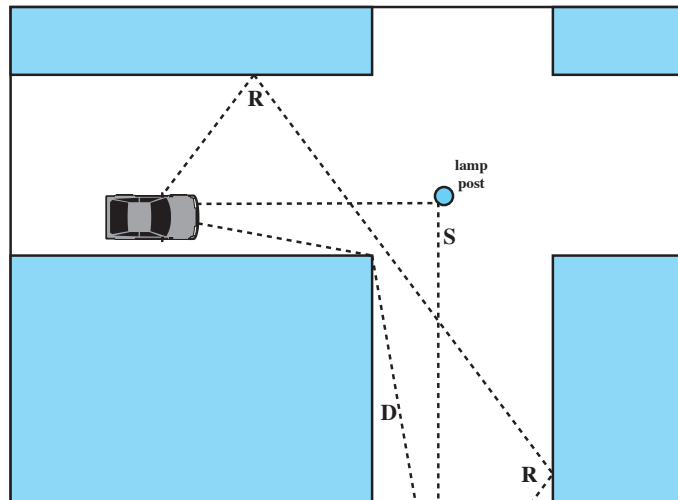

CS420/520 Axel Krings

Page 27

Sequence 12

## Effects of Multipath Propagation

---

- Signals may cancel out due to phase differences
- Inter-symbol Interference (ISI)
  - Sending narrow pulse at given frequency between fixed antenna and mobile unit
  - Channel may deliver multiple copies at different times
  - Delayed pulses act as noise making recovery of bit information difficult
  - Timing changes as mobile unit moves
    - Harder to design signal processing to filter out multipath effects

CS420/520 Axel Krings

Page 28

Sequence 12

## Two Pulses in Time-Variant Multipath (Figure 10.8)

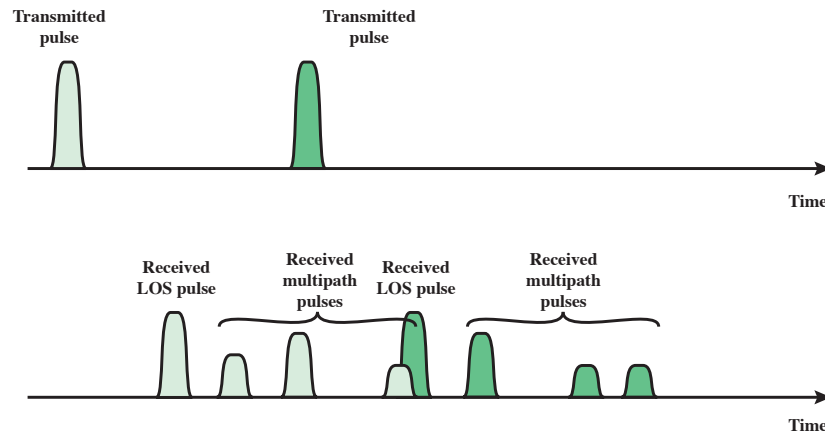

## Types of Fading

- Fast fading
  - Rapid changes in strength over distances about half wavelength
    - 900MHz wavelength is 0.33m
    - 20-30dB
- Slow fading
  - Slower changes due to user passing different height buildings, gaps in buildings etc.
  - Over longer distances than fast fading
- Flat fading
  - Nonselective
  - Affects all frequencies in same proportion
- Selective fading
  - Different frequency components affected differently

## **Error Compensation Mechanisms (1)**

---

- Forward error correction
  - Applicable in digital transmission applications
  - Typically, ratio of total bits sent to data bits between 2 and 3
  - Big overhead
    - Capacity one-half or one-third
    - Reflects difficulty of mobile wireless environment

## **Error Compensation Mechanisms (2)**

---

- Adaptive equalization
  - Applied to transmissions that carry analog or digital information
  - Used to combat inter-symbol interference
  - Gathering the dispersed symbol energy back together into its original time interval
  - Techniques include so-called lumped analog circuits and sophisticated digital signal processing algorithms



## Error Compensation Mechanisms (3)

- Diversity
  - Based on fact that individual channels experience independent fading events
  - Use multiple logical channels between transmitter and receiver
  - Send part of signal over each channel
  - Does not eliminate errors, but reduces error rate
  - Equalization, forward error correction then cope with reduced error rate
  - May involve physical transmission path
    - Space diversity
    - Multiple nearby antennas receive message or collocated multiple directional antennas
  - More commonly, diversity refers to frequency or time diversity, e.g., spread spectrum

## Wireless Network Generations

**Table 10.1**

Technology	1G	2G	2.5G	3G	4G
Design began	1970	1980	1985	1990	2000
Implementation	1984	1991	1999	2002	2012
Services	Analog voice	Digital voice	Higher capacity packetized data	Higher capacity, broadband	Completely IP based
Data rate	1.9. kbps	14.4 kbps	384 kbps	2 Mbps	200 Mbps
Multiplexing	FDMA	TDMA, CDMA	TDMA, CDMA	CDMA	OFDMA, SC-FDMA
Core network	PSTN	PSTN	PSTN, packet network	Packet network	IP backbone

## **First Generation (1G)**

---

- Original cellular telephone networks
- Analog traffic channels
- Designed to be an extension of the public switched telephone networks
- The most widely deployed system was the Advanced Mobile Phone Service (AMPS)
- Also common in South America, Australia, and China

## **Spectral Allocation In North America**

---

- Two 25-MHz bands are allocated to AMPS
  - One from BS to mobile unit (869–894 MHz)
  - Other from mobile to base station (824–849 MHz)
- Each of these bands is split in two to encourage competition
  - In each market two operators can be accommodated
  - Thus operator is allocated only 12.5 MHz in each direction
- Channels
  - channels spaced 30 kHz apart
  - total of 416 channels per operator
  - 21 channels allocated for control
  - 395 to carry calls
  - Control channels are data channels operating at 10 kbps
  - Conversation channels are analog using freq. modulation (FM)
  - Control information is also sent on conversation channels in bursts as data
- Number of channels inadequate for most major markets
- For AMPS, frequency reuse was exploited

## **Second Generation (2G)**

---

- Developed to provide higher quality signals, higher data rates for support of digital services, and greater capacity
- Key differences between 1G and 2G include:
  - Digital traffic channels
  - Encryption
  - Error detection and correction
  - Channel access
    - Time division multiple access (TDMA)
    - Code division multiple access (CDMA)

## **Second Generation cont.**

---

- Higher quality signals, higher data rates
- Support of digital services
- Greater capacity
- Digital traffic channels
  - Support digital data
  - Voice traffic digitized
  - User traffic (data or digitized voice) converted to analog signal for transmission
- Encryption
  - Simple to encrypt digital traffic
- Error detection and correction
  - (See chapter 6 and 16)
  - Very clear voice reception

## Code Division Multiple Access

---

- Self-jamming
  - Unless all mobile users are perfectly synchronized, arriving transmissions from multiple users will not be perfectly aligned on chip boundaries
  - Spreading sequences of different users not orthogonal
  - Some cross correlation
  - Distinct from either TDMA or FDMA
    - In which, for reasonable time or frequency guardbands, respectively, received signals are orthogonal or nearly so
- Near-far problem
  - Signals closer to receiver are received with less attenuation than signals farther away
  - Given lack of complete orthogonality, transmissions from more remote mobile units may be more difficult to recover

## RAKE Receiver

---

- If multiple versions of signal arrive more than one chip interval apart, receiver can recover signal by correlating chip sequence with dominant incoming signal
  - Remaining signals treated as noise
- Better performance if receiver attempts to recover signals from multiple paths and combine them, with suitable delays
- Original binary signal is spread by XOR operation with chipping code
- Spread sequence modulated for transmission over wireless channel
- Multipath effects generate multiple copies of signal
  - Each with a different amount of time delay ( $\tau_1$ ,  $\tau_2$ , etc.)
  - Each with a different attenuation factors ( $a_1$ ,  $a_2$ , etc.)
  - Receiver demodulates combined signal
  - Demodulated chip stream fed into multiple correlators, each delayed by different amount
  - Signals combined using weighting factors estimated from the channel

## Principle of RAKE Receiver

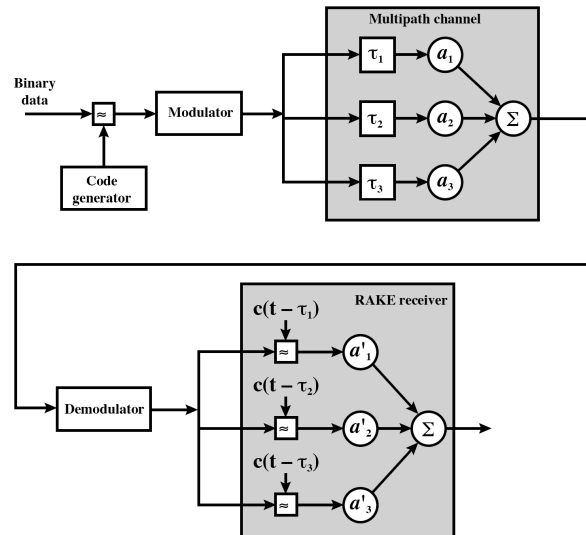

CS420/520 Axel Krings

Page 45

Sequence 12

## DSSS

- **Direct-Sequence Spread Spectrum**
- Spreads 19.2 kbps to 1.2288 Mbps
- Using one row of Walsh matrix
  - Assigned to mobile station during call setup
  - If 0 presented to XOR, 64 bits of assigned row sent
  - If 1 presented, bitwise XOR of row sent
- Final bit rate 1.2288 Mbps
- Bit stream modulated onto carrier using QPSK
  - Data split into I and Q (in-phase and quadrature) channels
  - Data in each channel XORed with unique short code
    - Pseudorandom numbers from 15-bit-long shift register

CS420/520 Axel Krings

Page 46

Sequence 12

## Third Generation (3G)

---

- Objective to provide fairly high-speed wireless communications to support multimedia, data, and video in addition to voice
- ITU's International Mobile Telecommunications for the year 2000 (IMT-2000) initiative defined ITU's view of third-generation capabilities as:
  - Voice quality comparable to PSTN
  - 144 kbps available to users in vehicles over large areas
  - 384 kbps available to pedestrians over small areas
  - Support for 2.048 Mbps for office use
  - Symmetrical and asymmetrical data rates
  - Support for packet-switched and circuit-switched services
  - Adaptive interface to Internet
  - More efficient use of available spectrum
  - Support for variety of mobile equipment
  - Flexibility to allow introduction of new services and technologies

## CDMA

---

- Dominant technology for 3G systems

### CDMA schemes:

- Bandwidth (limit channel to 5 MHz)
- 5 MHz reasonable upper limit on what can be allocated for 3G
- 5 MHz is adequate for supporting data rates of 144 and 384 kHz

- Chip rate

- Given bandwidth, chip rate depends on desired data rate, need for error control, and bandwidth limitations
- Chip rate of 3 Mcps or more is reasonable

## **CDMA – Multirate**

---

- Provision of multiple fixed-data-rate channels to user
- Different data rates provided on different logical channels
- Logical channel traffic can be switched independently through wireless and fixed networks to different destinations
- Can flexibly support multiple simultaneous applications
- Can efficiently use available capacity by only providing the capacity required for each service

## **Fourth Generation (4G)**

---

- Minimum requirements:
  - Be based on an all-IP packet switched network
  - Support peak data rates of up to approximately 100 Mbps for high-mobility mobile access and up to approximately 1 Gbps for low-mobility access such as local wireless access
  - Dynamically share and use the network resources to support more simultaneous users per cell
  - Support smooth handovers across heterogeneous networks
  - Support high quality of service for next-generation multimedia applications

## **Fourth Generation (4G)**

---

- Provide **ultra-broadband Internet access** for a variety of mobile devices including laptops, smartphones, and tablet PCs
- **Support Mobile Web access** and high-bandwidth applications such as high-definition mobile TV, mobile video conferencing, and gaming services
- Designed to maximize bandwidth and throughput while also maximizing spectral efficiency

## **Fourth Generation (4G)**

---

- WiMAX (Worldwide Interoperability for Microwave Access) is a wireless industry coalition for advancing the IEEE 802.16 standards for **Broadband Wireless Access (BWA)** networks.
  - IEEE 802.16 is a group of broadband wireless standards for Metropolitan Area Networks (MANs)



## 3G vs 4G

- 3G
  - connections between base station and switching office typically cable-based (copper/fiber)
  - Circuit switching enables voice connection between mobile and fixed phones (PSTN)
  - Internet access routed through switching office
- 4G
  - IP telephony and IP packet-switched connections for Internet access
  - Uses fixed broadband wireless access (BWA) WiMAX
  - 4G to 4G communication may never be routed over cable => all communication is IP via wireless links
  - Allows mobile-to-mobile video call/conferencing and simultaneous delivering voice and data services (browse while talking on phone)

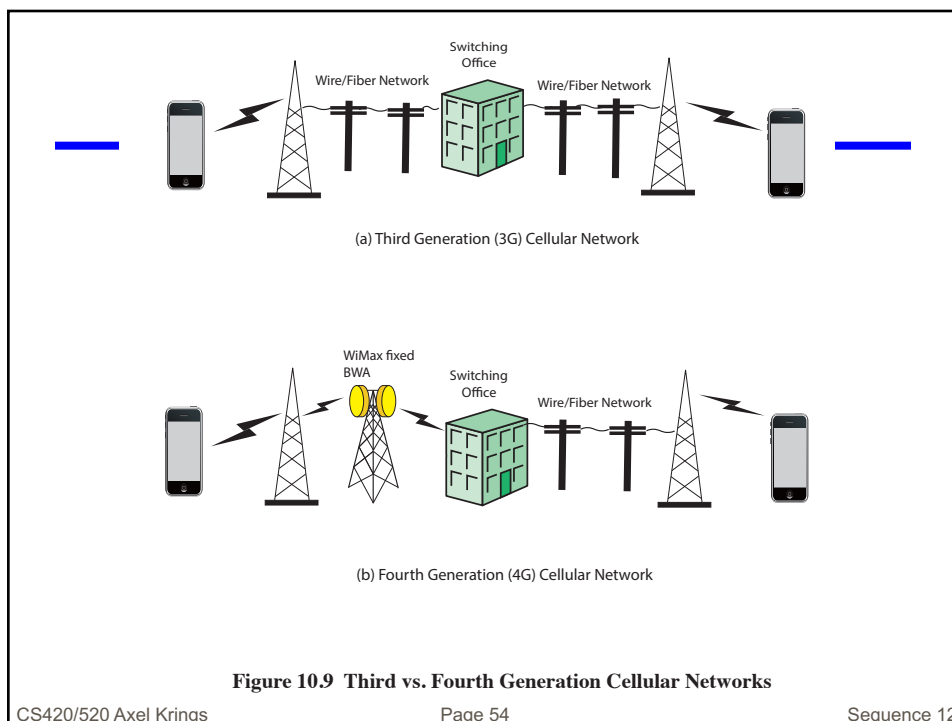

## LTE - Advanced

- Long Term Evolution (LTE)
- Uses orthogonal frequency division multiple access (OFDMA)

Two candidates have emerged for 4G standardization:

Long Term Evolution (LTE)

WiMax  
(from the IEEE 802.16 committee)

Developed by the Third Generation Partnership Project (3GPP), a consortium of North American, Asian, and European telecommunications standards organizations

## Comparison of Performance Requirements for LTE and LTE-Advanced

System Performance		LTE	LTE-Advanced
Peak rate	Downlink	100 Mbps @20 MHz	1 Gbps @100 MHz
	Uplink	50 Mbps @20 MHz	500 Mbps @100 MHz
Control plane delay	Idle to connected	<100 ms	< 50 ms
	Dormant to active	<50 ms	< 10 ms
User plane delay		< 5ms	Lower than LTE
Spectral efficiency (peak)	Downlink	5 bps/Hz @2x2	30 bps/Hz @8x8
	Uplink	2.5 bps/Hz @1x2	15 bps/Hz @4x4
Mobility		Up to 350 km/h	Up to 350—500 km/h

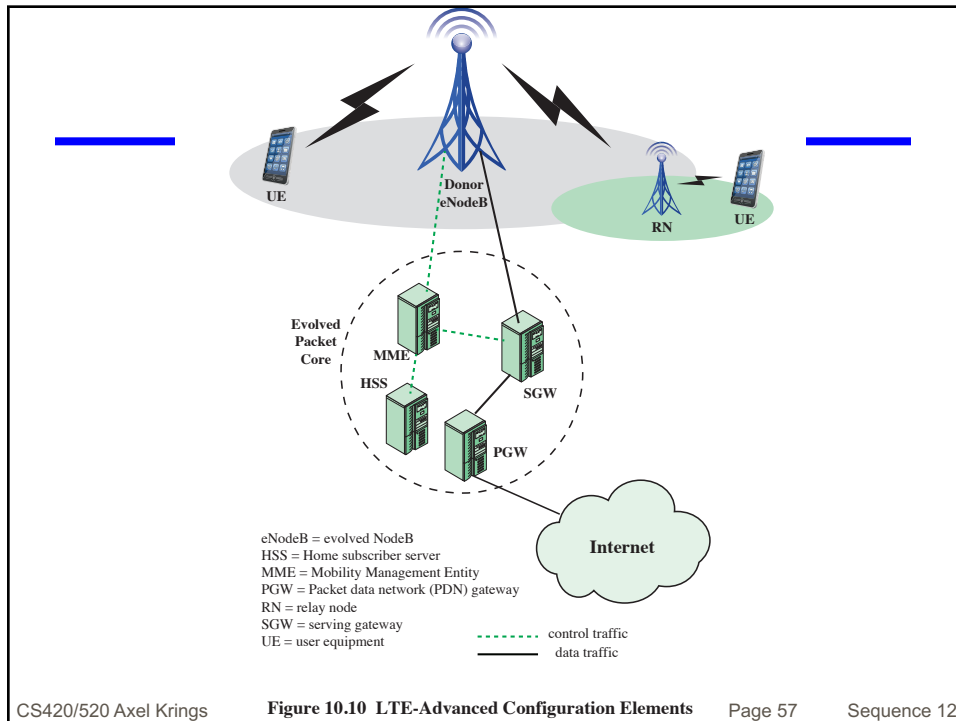

## Femtocells

- A low-power, short range, self-contained base station
  - Term has expanded to encompass higher capacity units for enterprise, rural and metropolitan areas
  - By far the most numerous type of small cells
  - Now outnumber macrocells
- Bottom line: it is your miniature cell phone tower to boost your wireless signal at home.
  - Key attributes include:
    - IP backhaul
    - Self-optimization
    - Low power consumption
    - Ease of deployment

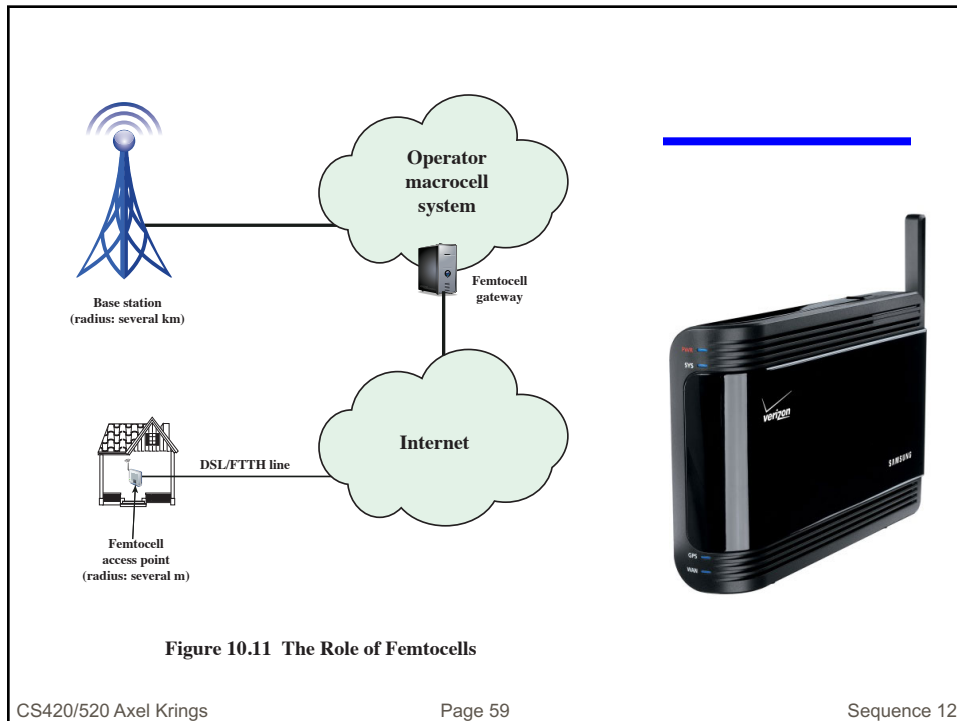

## LTE-Advanced

- Relies on two key technologies to achieve high data rates and spectral efficiency:
  - Orthogonal frequency-division multiplexing (OFDM)
    - Signals have a high peak-to-average power ratio (PAPR), requiring a linear power amplifier with overall low efficiency
    - This is a poor quality for battery-operated handsets
  - Multiple-input multiple-output (MIMO) antennas
  - Uses OFDMA for uplink
  - Uses SC-FDMA (SC = Single-carrier)
    - Has better peak-to-average power ratio (PAPR)

# LTE-Advanced

---

- Frequency-Division-Duplex (FDD)
- Time-Division-Duplex (TDD)
- Both widely deployed

PARAMETER	LTE-TDD	LTE-FDD
Paired spectrum	Does not require paired spectrum as both transmit and receive occur on the same channel.	Requires paired spectrum with sufficient frequency separation to allow simultaneous transmission and reception.
Hardware cost	Lower cost as no diplexer is needed to isolate the transmitter and receiver. As cost of the UEs is of major importance because of the vast numbers that are produced, this is a key aspect.	Diplexer is needed and cost is higher.
Channel reciprocity	Channel propagation is the same in both directions which enables transmit and receive to use one set of parameters.	Channel characteristics are different in the two directions as a result of the use of different frequencies.
UL / DL asymmetry	It is possible to dynamically change the UL and DL capacity ratio to match demand.	UL / DL capacity is determined by frequency allocation set out by the regulatory authorities. It is therefore not possible to make dynamic changes to match capacity. Regulatory changes would normally be required and capacity is normally allocated so that it is the same in either direction.
Guard period / guard band	Guard period required to ensure uplink and downlink transmissions do not clash. Large guard period will limit capacity. Larger guard period normally required if distances are increased to accommodate larger propagation times.	Guard band required to provide sufficient isolation between uplink and downlink. Large guard band does not impact capacity.
Discontinuous transmission	Discontinuous transmission is required to allow both uplink and downlink transmissions. This can degrade the performance of the RF power amplifier in the transmitter.	Continuous transmission is required.
Cross slot interference	Base stations need to be synchronized with respect to the uplink and downlink transmission times. If neighboring base stations use different uplink and downlink assignments and share the same channel, then interference may occur between cells.	Not applicable

**Table 10. 3**

**Characteristics of TDD and FDD for LTE-Advanced**

(Table can be found on page 325 in textbook)

Page 62
Sequence 12

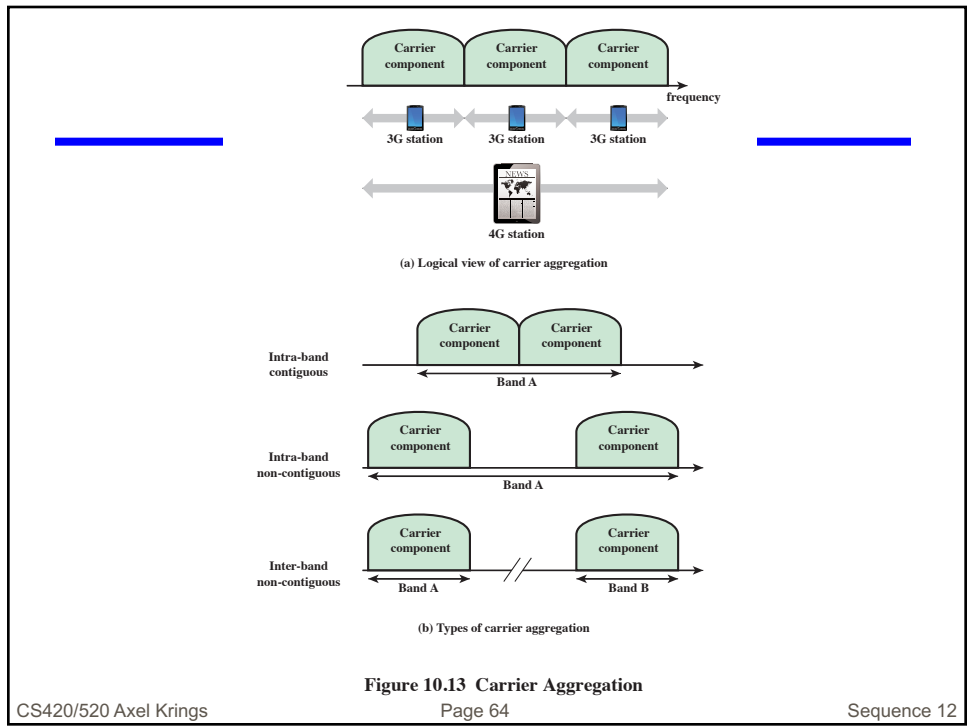
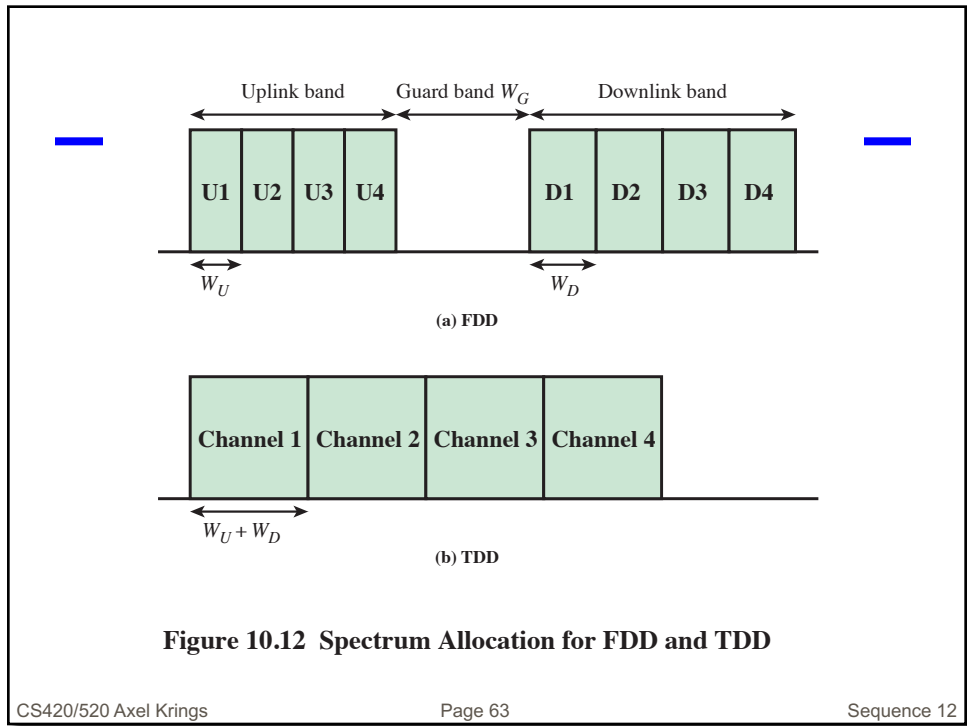

## Summary

---

- Principles of cellular networks
  - Cellular network organization
  - Operation of cellular systems
  - Mobile radio propagation effects
  - Fading in the mobile environment
- Cellular network generations
  - First generation
  - Second generation
  - Third generation
  - Fourth generation
- LTE-Advanced
  - Architecture
  - Transmission characteristics